

OLIS

OLIS

ELECTRIC TILTING BRATT PANS / BRASIERE RIBALTABILI ELETTRICHE

700

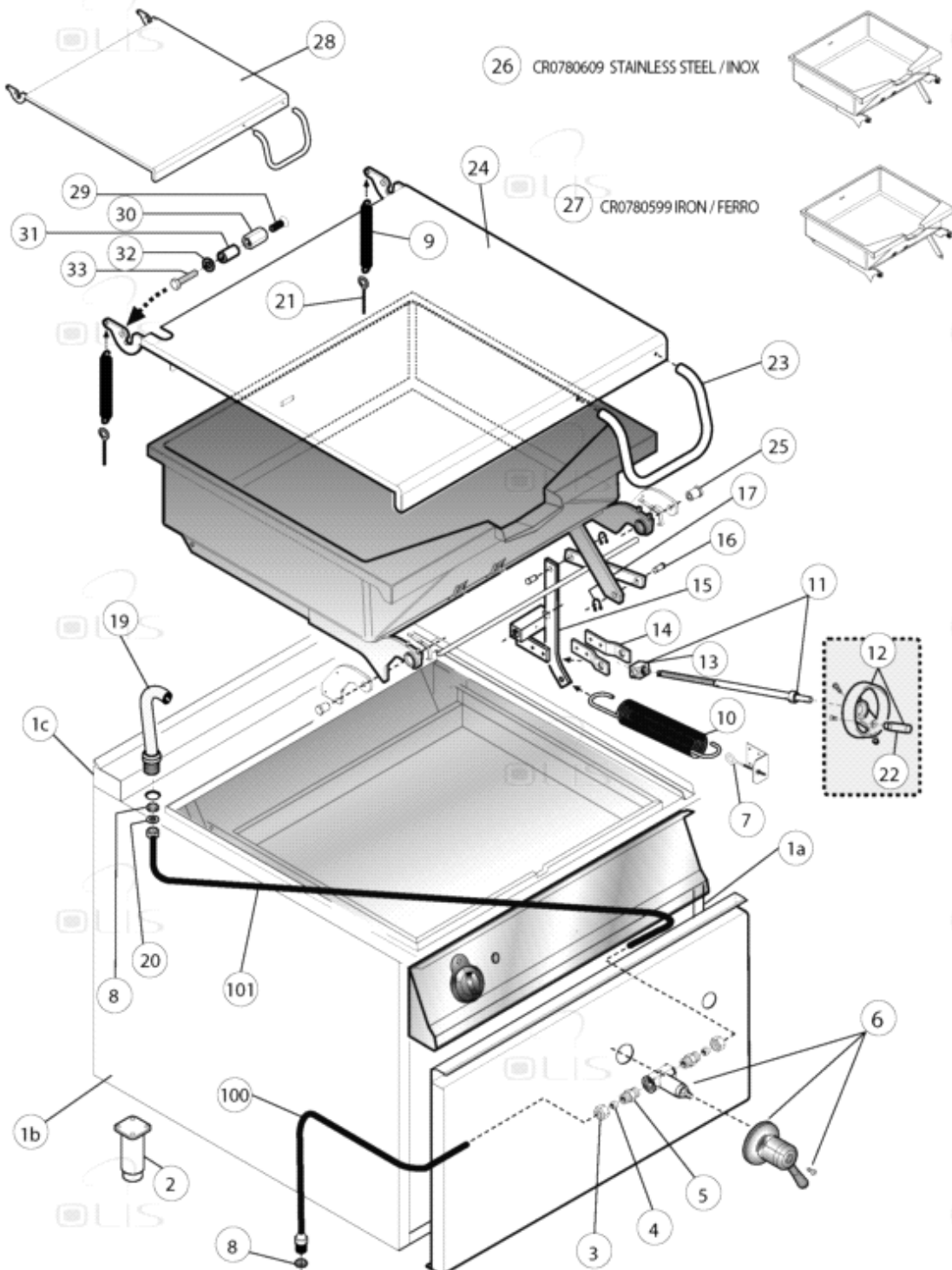









Table_A

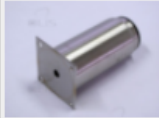





EDITION 10 2015

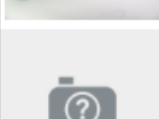



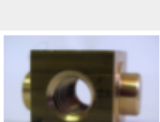

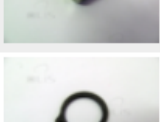
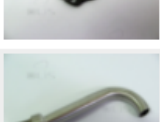
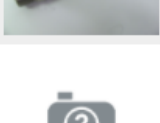

CR0780629
CR0780619



74/10
74/10





KBEI
KBE

foto	Pos	Codice	Codice precedente	Quantità	Consigliato	Da	A	Descrizione	Pow	Diam
	0002	MA6086113		4				ASS.PIEDINO /13/4 INOX FLANG.H150		
	0003	MA673100		2				DADO M20X1,5 /12 PEL 0907		
	0004	BN6A016300	MA673300	2				BICONO DA 12 PEL 0906		
	0005	CR0588920		2				NIPPLO M20x1.5 - 1/2		
	0006	SI0102613		1	✓			RUBINETTO DI ARRESTO DRITTO		
	0007	CR0589730		1				OCCHIELLO TENDITORE M10 ZINCATO		
	0008	MACM066200		2				DADO 1/2		
	0009	CR0589520		2				MOLLA BILANCIAMENTO COPERCHIO BR9 M80		
	0010	CR0736120		1				MOLLA BILANCIAMENTO VASCA BRASIERA 700		

	0011	CR0589590		1			ASS.VITE BRASIERA 900		
	0012	MA1475201	MA1475291	1			VOLANTINO [C]		
	0013	MACM184300		1			MADREVITE BRASIERA		
	0014	CR0589560		2			SUPPORTO MADREVITE BRASIERA		
	0015	CR0736130		1			SOLLEVAMENTO VASCA BRASIERA 700 (KB)		
	0016	CR0589710		2			PERNO BIELLA		
	0017	CR0589720		2			ANELLO DI SICUREZZA ALBERO 14 UNI 7435		
	0019	CR0681381		1			EROGATORE BRASIERA		
	001a	CR0732570		1			FIANCO [C] BRASIERA 700 DX		

	001b	CR0732560		1			FIANCO [C] BRASIERA 700 SX		
	001c	CR0689670		1			SCHIENALE MONOBLOCCO M80 700		
	0020	MA14072299		1			GUARNIZIONE PER FLESSIBILE 1/2		
	0021	CR0589730		2			OCCHIELLO TENDITORE M10 ZINCATO		
	0022	MA77122500		1			IMPUGNATURA VOLANTINO ART.612/8		
	0023	CR0682470		1			MANIGLIA COPERCHIO BRASIERA 900		
	0024	CR0737060		1			COPERCHIO [C] BRASIERA 700		
	0025	CR0589840		2			PERNO VASCA BRASIERA [C]		
	0026	CR0732591		1			ASSIEME VASCA INOX BRASIERA 700 M80		

	0028	CR0732690		1				COPERCHIO [C] BRASIERA 700		
	0029	CR0686220		2				VITE [C] M5X8 UNI EN ISO 7046		
	0030	CR0681371		2				DADO [C]		
	0031	CR0681090		2				BOCCOLA [C] COPERCHIO BRASIERA		
	0032	MA15830699		2				RONDELLA [C] - MINIMO 10 PEZZI O MULTIPLI		
	0033	CR0682730		2				VITE [C] M8X20 UNI EN ISO 24017 (Min 10 pz o multipli)		
	0100	BN6A016300	MA673300	1				BICONO DA 12 PEL 0906		
	0100	CR0736800		1				CONDUTTURA [C] BRASIERA 700 ING. ACQUA		
	0100	MA673100		1				DADO M20X1,5 /12 PEL 0907		
	0100	MACM066200		1				DADO 1/2		

	0101	BN6A016300	MA673300	1			BICONO DA 12 PEL 0906		
	0101	CR0736770		1			CONDUTTURA [C] BRASIERA 700 EROGATORE		
	0101	MA14072299		1			GUARNIZIONE PER FLESSIBILE 1/2		
	0101	MA673100		1			DADO M20X1,5 /12 PEL 0907		



OLIS

ELECTRIC TILTING BRATT PANS / BRASIERE RIBALTABILI ELETTRICHE

700

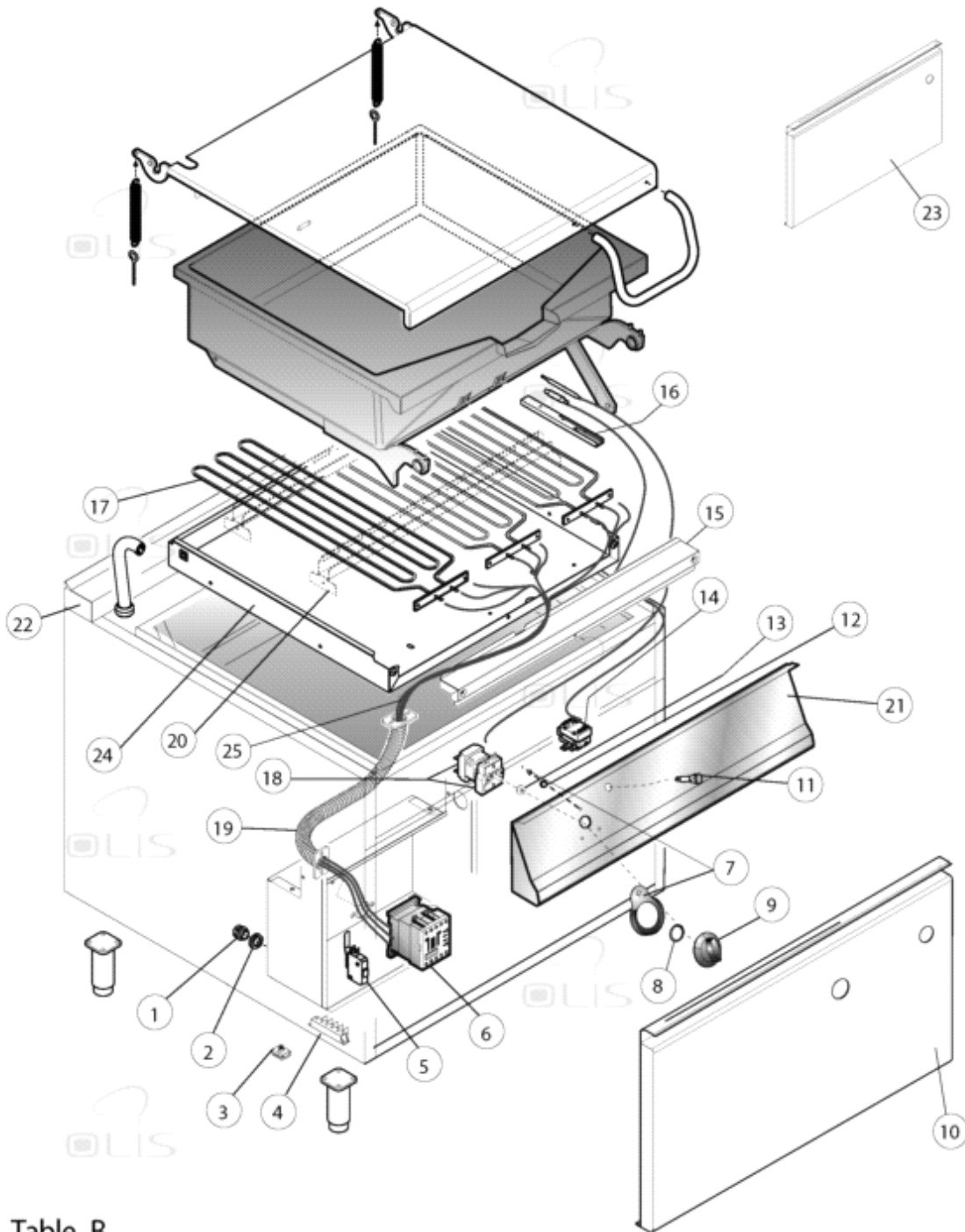









Table_B



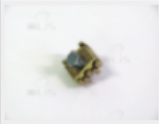



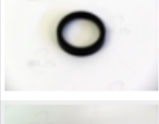

EDITION 10 2015



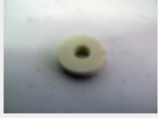

CR0780629
CR0780619

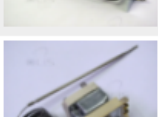
74/10
74/10

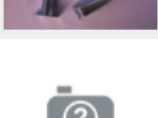
KBEI
KBE

foto	Pos	Codice	Codice precedente	Quantità	Consigliato	Da	A	Descrizione	Pow	Diam
	0001	MA1037115100		1				PRESSACAVO OBO V-TEC PG16		
	0002	MA1037115200		1				CONTRODADO OBO 116/PG16 NY		
	0003	MA1878400		1				MORSETT.A PETTINE BM5251 X EQUIPOT.		
	0004	CR0588170		1	✓			MORSETTIERA 6 POLI FV122 B 40A-450V		
	0005	MA1037111300		1	✓			MICROSWITCH HONEYWELL V15T16- CZ300A03		
	0006	MACM187301		1	✓			TELERUTTORE SIEMENS 3RT2016-1AP01		
	0007	CR0794170R		1	✓			KIT SOTTOMANOPOLA INDICE ANTERIORE OLIS		
	0008	BN2519490		1				GUARNIZ. MANOPOLA V- SEALVA40/NBR		
	0009	CR0794270		1	✓			BN-MANOPOLA TERMOSTATO BRASIERA OLIS		
	0010	CR0791250		1				FACCIATA BRAS. EL. 700 C/CARICO H2O OLIS		

	0011	CR0587500		1	✓		SPIA ARANCIO C.GUARNIZIONE 3122000478		
	0012	CR0588510		3			GUARNIZIONE CRUSCOTTI ELETTRICI 900		
	0013	CR0587650		1	✓		GUARNIZIONE ALBERINO COMP.ELETTRICI		
	0014	MA1878500		1	✓		TERMOSTATO 360Â°C		
	0015	CR0689610		1			PROTEZIONE [C] BRASIERA ELETTRICA M80 TERMINALI		
	0016	CR0685060		1			SEDE BULBI BRASIERA EL. 900 M120		
	0017	CR0732870		3	✓		RESISTENZA BRASIERA 700		
	0018	CR0581280		1	✓		TERMOSTATO C/COMMUTAT.		
	0019	MACM199801		1			FLESSIBILE BRASIERA ELETTRICA		
	0020	CR0683270		2			SUPPORTO [C] RESISTENZE BRASIERA 900 M80		

 NO IMAGE	0021	CR0791040		1			ASS.CRUSCOTTO BRASIERA EL. OLIS		
 NO IMAGE	0022	CR0732930		1			CAMINO [C] BRASIERA ELETTRICA 700		
 NO IMAGE	0023	CR0791600		1			FACCIATA BRASIERA EL. 70/90 M80 OLIS		
 NO IMAGE	0024	CR0732840		1			SCATOLA [C] RESISTENZE BRASIERA 700		
 NO IMAGE	0025	CR0732991	CR0732990	1			CABLAGGIO BRASIERA 700		